

# Glassfibre Flagstaffs

## External Halyard

### ASSEMBLY INSTRUCTIONS

October 2018 v4

**PLEASE CHECK THAT THE DIRECTION THE HINGE IS SET IN, LEAVES ENOUGH ALLOWANCE FOR THE FLAGSTAFF THAT IS TO BE INSTALLED**

1. Check the contents. Assemble the hinging plate onto the 3 foundation bolts with the flagstaff hinging lugs uppermost and lock into position with the 3 flat nuts as supplied. (See Fig 1)
2. Connect the 3 long nuts as shown. (See Fig 2). Place the flagstaff locking ring over the long nut next to the flagstaff hinge lug as shown (See Fig 3)
3. To ensure that the foundation bolts remain parallel to one another during the concreting, lock the top template plate into position using the 3 set screws and anti vibration washers as shown. (See Fig 4)
4. Concrete the foundation assembly into position using the foundation size in the chart on page 3. Try to ensure that the ground foundation is as level as possible.
5. When the concrete has set, remove the set screws, template and locking ring.
6. Thread the halyard through the finial. Push the finial onto the top of the pole. (See Fig 5)  
**THE FLAGSTAFF NEEDS TO BE DOWN TO DO THIS, KEEP THE FINIAL RAISED OFF THE GROUND TO AVOID DAMAGING IT.**
7. Attach the cleat to the pole in the pre drilled position using the screws provided. (See Fig 6)

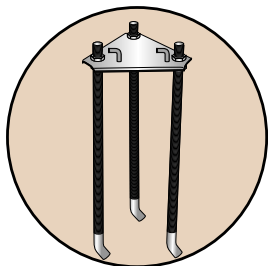

Fig 1,

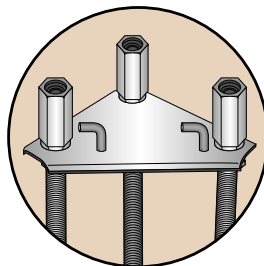

Fig 2,

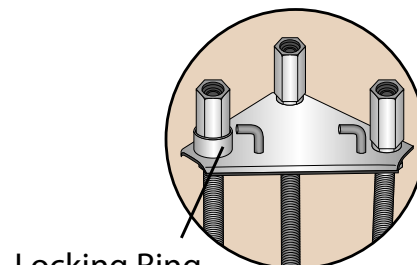

Fig 3,

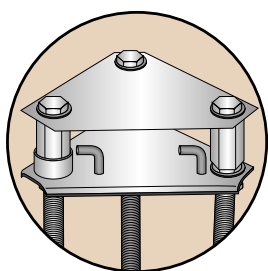

Fig 4,

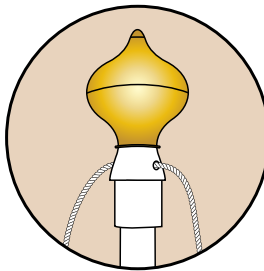

Fig 5,

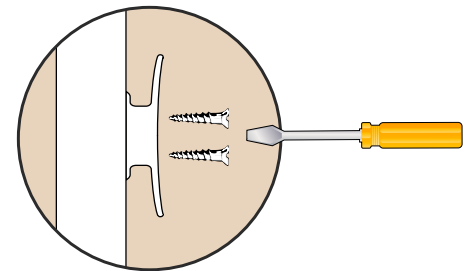

Fig 6,

# Glassfibre Flagstaffs

## External halyard

### ASSEMBLY INSTRUCTIONS

October 2018 v4

8. Assemble the flagstaff onto the lugs, place the locking ring back over the long nut next to the hinging lug. (See Fig 7)
9. Raise the flagstaff, insert and tighten the set screws and anti-vibration washers. (See Fig 8)  
**IT IS RECOMMENDED THAT AT LEAST TWO PEOPLE ARE INVOLVED IN RAISING THE FLAGSTAFF**
10. Check the flagstaff is upright with a spirit level. Adjustments can be made by loosening the set screws and adjusting the long nut to bring the flagstaff perpendicular. (See Fig 9) Once satisfied, tighten the three flat nuts back up against the baseplate.
11. Tighten the set screws whilst preventing the long nut from rotating. (See Fig 10)  
**IS IS RECOMMENDED THAT ALL NUTS SHOULD BE CHECKED ON A REGULAR BASIS, TO ENSURE THAT THEY ARE FULLY TIGHTENED HOME.**
12. Ensure flag is the correct way up, tie an end of the halyard to each of the D-rings on the flag. (See Fig 11)
13. Hoist the flag to the top of the pole, wrap the halyard around the pole once and then wrap it around the cleat. If the flag has eyelets and an s-clip, hook the s-clip to the halyard to keep the flag close to the pole. (See Fig 12)

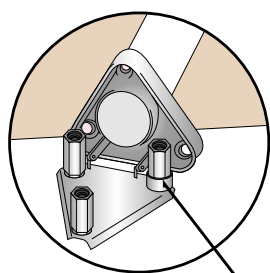

Fig 7, Locking Ring

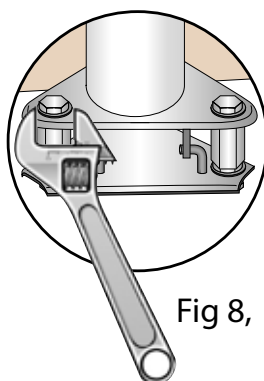

Fig 8,

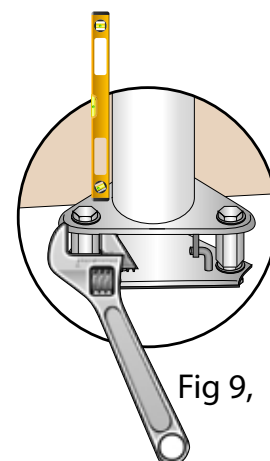

Fig 9,

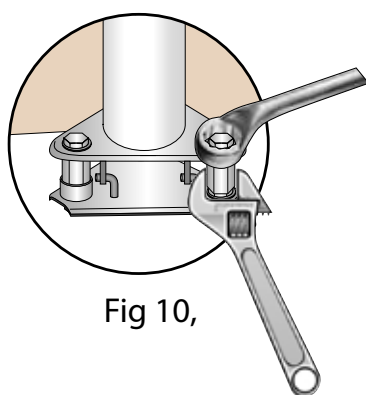

Fig 10,

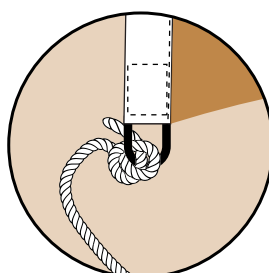

Fig 11,

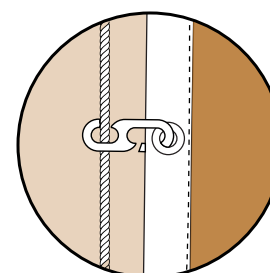

Fig 12,

## WARNINGS

**BEFORE INSTALLATION, CHECK FOR UNDERGROUND SERVICES**

**Do not fly flag when wind speed exceeds Force 7 (32mph)**

**It remains the responsibility of the user to establish the suitability of the product /s for the use/s to which they are put**

# Glassfibre Flagstaffs

## External halyard

### ASSEMBLY INSTRUCTIONS

October 2018 v4



3 Foundation Bolts	1 Onion Finial
3 Flat Nuts	1 Cone
3 Long Nuts	1 Halyard
3 Pairs of Anti-Vibration Washers	1 Cleat
3 Set Screws	2 Screws for cleat
1 Hinging Plate for Flagstaff	
1 Locking Ring for Flagstaff	
1 Top Template plate	

**CONTENTS**

### Glassfibre Flagstaff Specifications

Flagstaff Height - A	6m	8m	10m	12m
Butt Diameter	115mm	115mm	135mm	135mm
Top Diameter	65mm	65mm	65mm	65mm
Weight inc. Baseplate	14kg	16kg	28kg	34kg
Weight Of Ground Plate inc. Bolts/Nuts/Washers	6kg	6kg	6kg	6kg
Additional Weight Of Internal Halyard System	4kg	4kg	4kg	4kg
Maximum Flag Size	2m	2.5m	3m	3.5m
Baseplate Dimension - B	200mm	200mm	200mm	200mm
Hole Centres - C	168mm	168mm	168mm	168mm
Ground Plate Dimension - D	200mm	200mm	200mm	200mm
Hole Centres - E	168mm	168mm	168mm	168mm
Bolt ( M20 ) Length - F	600mm	600mm	600mm	600mm
Foundation Depth*	800mm	1000mm	1000mm	1000mm
Foundation Square*	500mm	500mm	650mm	650mm

A tapered towards top

one-piece flagstaff

cylindrical towards butt

\*These are suggested dimensions only, actual measurements will depend on ground conditions

14 metre, 16 metre and 18 metre flagstaffs are available on application.

