

Glassfibre Flagstaffs

Internal Halyard

ASSEMBLY INSTRUCTIONS

October 2018 v5

PLEASE CHECK THAT THE DIRECTION THE HINGE IS SET IN, LEAVES ENOUGH ALLOWANCE FOR THE FLAGSTAFF THAT IS TO BE INSTALLED

1. Check the contents.
2. Assemble the hinging plate onto the 3 foundation bolts with the flagstaff hinging lugs uppermost and lock into position with the 3 flat nuts as supplied. (See Fig 1)
3. Connect the 3 long nuts as shown. (See Fig 2). Place the flagstaff locking ring over the long nut next to the flagstaff hinge lug as shown (See Fig 3)
4. To ensure that the foundation bolts remain parallel to one another during the concreting, lock the top template plate into position using the 3 set screws and anti vibration washers as shown. (See Fig 4)
5. Concrete the foundation assembly into position using the foundation size in the chart on page 3. Try to ensure that the ground foundation is as level as possible.
6. When the concrete has set, remove the set screws, template and locking ring.
8. Remove the sleeving from pole, release the halyard and pass through the cone. (See Fig 5) Place the cone onto the top of the pole, keeping the halyard tension tight.
9. Thread the halyard through the white ball and tie onto the clip provided. (See Fig 6)
10. Slide the assembled weight over the cone making sure that it is the correct way up, (See Fig 7) and clip on the weight. (See Fig 8)

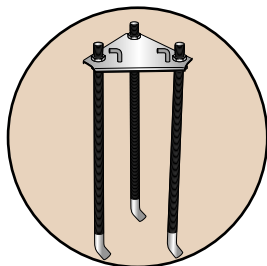

Fig 1,

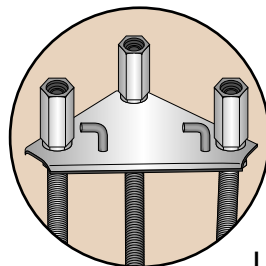

Fig 2,

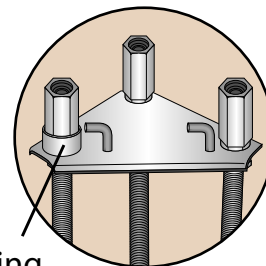

Fig 3,

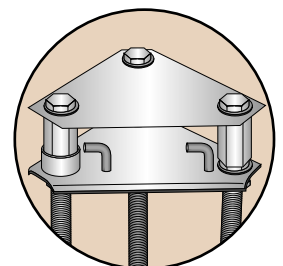

Fig 4,

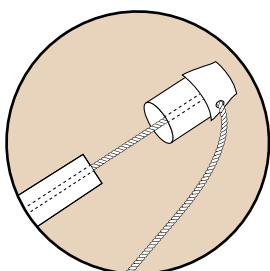

Fig 5,

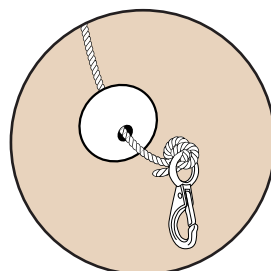

Fig 6,

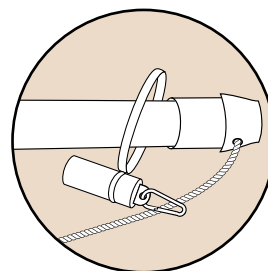

Fig 7,

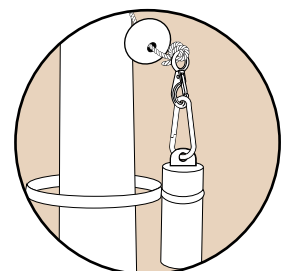

Fig 8,

Glassfibre Flagstaffs

Internal halyard

ASSEMBLY INSTRUCTIONS

October 2018 v5

11. Screw on the onion finial. (See Fig 9) **KEEP FINIAL RAISED OFF THE GROUND TO AVOID DAMAGING IT**
12. Assemble the flagstaff onto the lugs, place the locking ring back over the long nut next to the hinging lug. (See Fig 9)
13. Raise the flagstaff, insert and tighten the set screws and anti-vibration washers. (See Fig 10)
IT IS RECOMMENDED THAT AT LEAST TWO PEOPLE ARE INVOLVED IN RAISING THE FLAGSTAFF
14. Check the flagstaff is upright with a spirit level. Adjustments can be made by loosening the set screws and adjusting the long nut to bring the flagstaff perpendicular. (See Fig 11) Once satisfied, tighten the three flat nuts back up against the baseplate.
15. Tighten the set screws whilst preventing the long nut from rotating. (See Fig 12)
IS IS RECOMMENDED THAT ALL NUTS SHOULD BE CHECKED ON A REGULAR BASIS, TO ENSURE THAT THEY ARE FULLY TIGHTENED HOME.
16. Wind the winch to bring the halyard and weight down, ensuring flag is the correct way up, clip the halyard onto the top D-ring on the flag, (See Fig 13) and clip the weight onto the bottom dring. (See Fig 14)
17. If applicable, Secure plastic ties through the eyelets and around the pole. DO NOT OVER-TIGHTEN (See Fig 15). Wind the winch to raise the flag to the top of the pole.

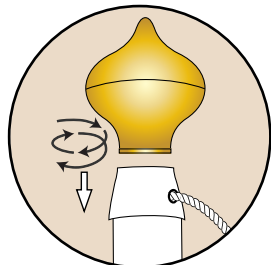

Fig 9,

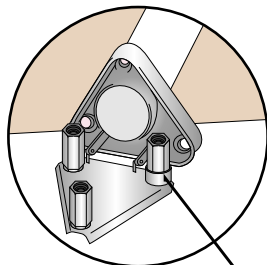

Fig 9, Locking Ring

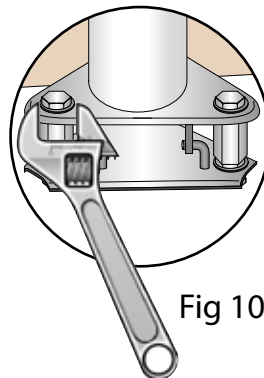

Fig 10,

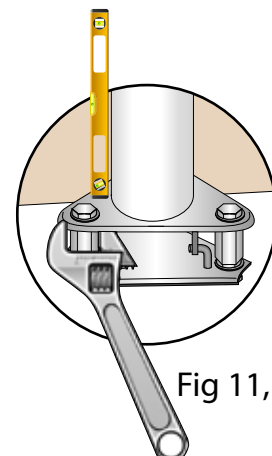

Fig 11,

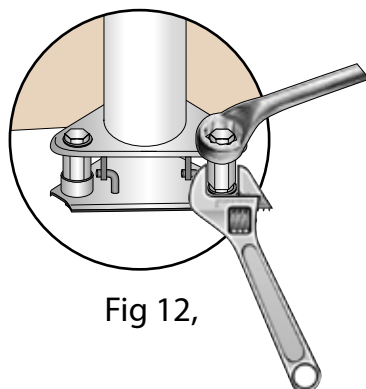

Fig 12,

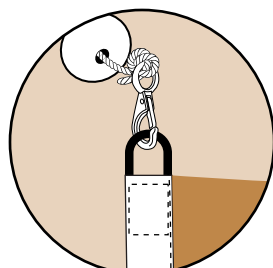

Fig 13,

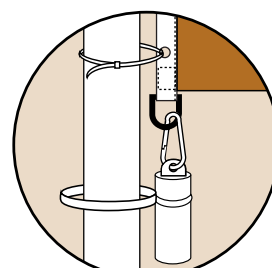

Fig 14,

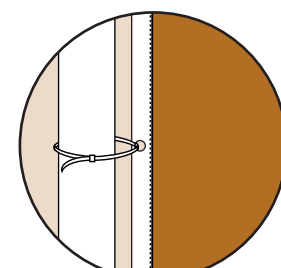

Fig 15,

WARNINGS

BEFORE INSTALLATION, CHECK FOR UNDERGROUND SERVICES
 Re-Usable Ties must never be over tightened
 Do not fly flag when wind speed exceeds Force 7 (32mph)
 It remains the responsibility of the user to establish the suitability
 of the product /s for the use/s to which they are put

Glassfibre Flagstaffs

Internal halyard

ASSEMBLY INSTRUCTIONS

October 2018 v5



3 Foundation Bolts	1 Onion Finial
3 Flat Nuts	1 Cone
3 Long Nuts	1 White Ball
3 Pairs of Anti-Vibration Washers	1 Clip
3 Set Screws	1 Weight
1 Hinging Plate for Flagstaff	
1 Locking Ring for Flagstaff	
1 Top Template plate	

CONTENTS

Glassfibre Flagstaff Specifications

Flagstaff Height - A	6m	8m	10m	12m
Butt Diameter	115mm	115mm	135mm	135mm
Top Diameter	65mm	65mm	65mm	65mm
Weight internal diameter	150mm	150mm	150mm	150mm
Packed Weight inc. Baseplate	14kg	16kg	28kg	34kg
Weight of Ground Plate inc. Bolts/Nuts/Washers	6kg	6kg	6kg	6kg
Additional Weight Of Internal Halyard System	4kg	4kg	4kg	4kg
Maximum Flag Size	2m	2.5m	3m	3.5m
Baseplate Dimension - B	200mm	200mm	200mm	200mm
Hole Centres - C	168mm	168mm	168mm	168mm
Ground Plate Dimension - D	200mm	200mm	200mm	200mm
Hole Centres - E	168mm	168mm	168mm	168mm
Bolt (M20) Length - F	600mm	600mm	600mm	600mm
Foundation Depth*	800mm	1000mm	1000mm	1000mm
Foundation Square*	500mm	500mm	650mm	650mm

*These are suggested dimensions only, actual measurements will depend on ground conditions

A tapered towards top

one-piece flagstaff

cylindrical towards butt

