

1. Check contents.

INSTALLATION

- 2a. For permanent installation, excavate a foundation, (see table for dimensions). Concrete the socket into place, use a level to check the socket is vertical and plumb sitting on the soil at the bottom of the hole and plumb checking at intervals as you infill the hole. **DO NOT SIT THE POLE ON CONCRETE.** Make sure there is minimum of 20mm and maximum if 100mm of socket left above ground. (see fig2a)
- 2b. For a temporary installation use a ground auger and pack with sharp sand and soil to secure the ground socket, use a level to check the socket is vertical and plumb checking at intervals as you infill the hole. Make sure there is maximum of 20mm, and maximum of 100mm of socket left above ground. (see fig 2b)
3. Place the weight over the main pole. (see fig 3a)
Ensure that the PTFE sheet lines the inside of the joint casing and the washer is in the bottom before connecting the curved tube with the joint to the main pole. (see fig 3b)
4. Slide the sleeve of the flag over the curved tube and down onto the main pole. (see fig 4)
5. Attach the weight onto the rope loop at the bottom of the flag. (see fig 5)
6. Insert the pole into the ground socket. (Two persons are recommended for erection process)
(Make sure the arm and flag can rotate freely clear of obstacles). (see fig 6)

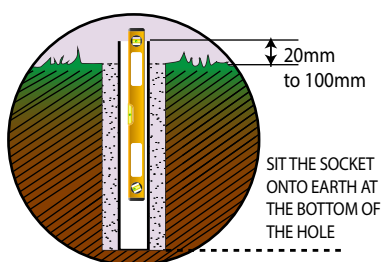

Fig 2a.

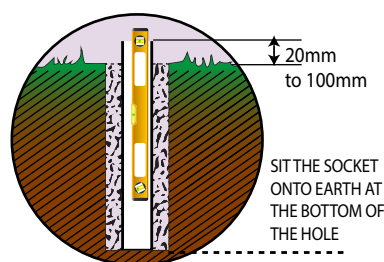

Fig 2b.

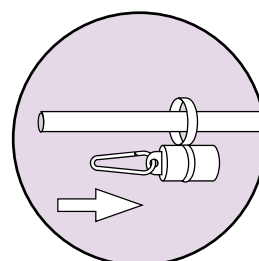

Fig 3b.

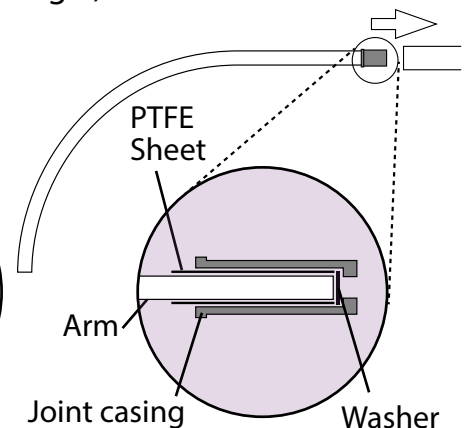

Fig 3b.

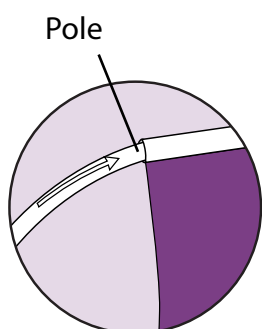

Fig 4.

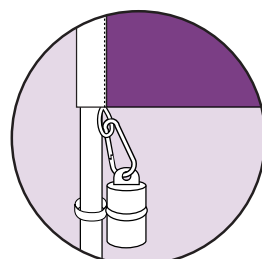

Fig 5.

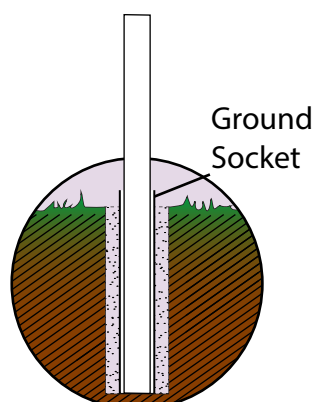

Fig 6.

FeatherPole

4.8m and 5.8m
With Ground Socket

ASSEMBLY INSTRUCTIONS

October 2018 v7

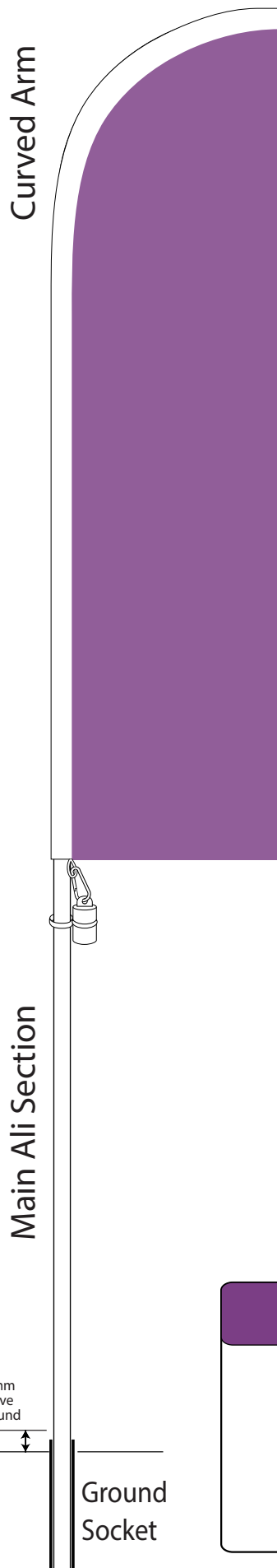

Main Ali Pole
1.5m Curved Arm and joint
Weight
Ground Socket

CONTENTS

Feather Pole Specifications

Pole Size	4.8m	5.8m
Height above ground	4.3m	5.3m
Length of curved top section	0.8m	0.8m
Inside diameter of curved section	25.63mm	25.63mm
Outside diameter of curved section	28.57mm	28.57mm
Length of main section	4m	5m
Inside diameter of main section	40.39mm	40.39mm
Outside diameter of main section	44.45mm	44.45mm
Wall thickness	2mm	2mm
Pole Weight	4kg	5kg
Ground socket internal diameter	46.5mm	46.5mm
Ground socket external diameter	53.5mm	53.5mm
Length of ground socket	600mm	600mm
Weight	300g	300g
Foundation square*	500mm	500mm
Foundation depth*	580mm	580mm
Max flag size	80cm x 320cm	80cm x 420cm

*These are suggested dimensions only, actual measurements will depend on ground conditions

WARNINGS

BEFORE INSTALLATION, CHECK FOR UNDERGROUND SERVICES

Do not fly flag when wind speed exceeds Force 7 (32mph)

It remains the responsibility of the user to establish the suitability of the product /s for the use/s to which they are put